

Godrej

seeTHRU RE 7

S-SERIES











VIDEO DOOR PHONE



USER MANUAL

WARNING AND CAUTION

Please make sure to follow the instructions to prevent any danger or property losses.

	Warning: Death or serious injury are expected.
	Do not disassemble, install, or repair this product on your own accord.
	Do not place the product near a hot or humid place.
	Do not forcibly bend the cord or put a heavy object on the product.
	Do not use water, thinner or a detergent used to wash oil products when you wash the exterior.
	Do not connect to other products while in use.
	Make sure to clean it by using a dry cloth to prevent any breakdown or electric shock.
	If the product emits a peculiar noise, odor or smoke, immediately cut off the power, and then contact the service center.
	
<hr/>	
	Caution: An injury or property losses are expected
	Make sure that dust or foreign substances are not gathered on the product.
	Make sure to prevent foreign substances from entering the product.
	Avoid direct rays of the sun or heating devices at a time of installation.
	Install the product in a flat and stable place.
	

1. FEATURES AND FUNCTIONS

Indoor Unit (Monitor)

- 7" color indoor monitor.
- Support only one door station.
- Color, brightness, ring volume and talk volume control.
- Hands free.
- Support 12V DC power adapter.
- Manual control knob for Color, brightness, ring volume and talk volume control.
- 16 ring melodies.
- Support Two way talk

Outdoor Unit

- 700TVL pin hole camera
- IR LED night vision.
- Door lock release

2. VDP (VIDEO DOOR PHONE) CONTENT

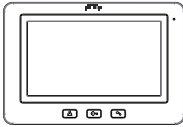

Indoor Unit-1

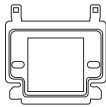

Bracket-1



Screw Pack



Outdoor Unit-1

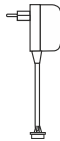

Adapter-1

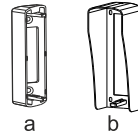

a. Oblique Base / b. Rain Shade
(Either-or)

3. INSTALLATION

A.Wiring

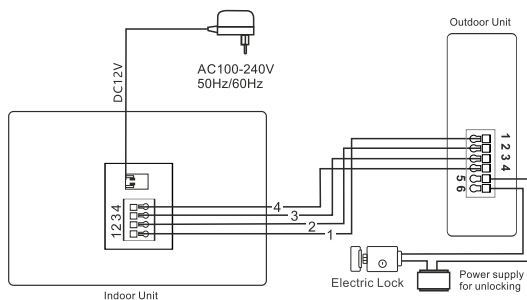

How to attach wires to terminals

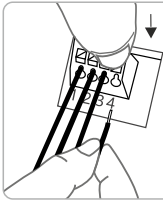

Press down on the button, and insert the wire in the corresponding hole. Release the button to clamp the wire in place. Gently pull the wire to see if they are clamped tightly.

- 1: Audio wire
- 2: Ground wire
- 3: Video wire
- 4: Power wire

- Connect the terminals 1, 2, 3 and 4 of the indoor unit to the terminals 1, 2, 3 and 4 of the outdoor unit respectively.

if the wiring distance is >15 meters, adopt the wire RVV4×0.3 mm².

If the wiring distance is 15-50 meters, adopt the wire RVV4×0.5 mm².

- Outdoor unit's terminals 5 and 6 outputs dry contact unlocking signals. Use wire RVV2×1.0 mm² when connecting the lock.

NOTE:

Before pressing the ELECTRIC LOCK button, terminals 5 and 6 are in the Normally Open state.

When pressing the button, terminals 5 and 6 are shorted and connected. The terminals are used to connect the electric lock that works in <30V and <3A, however, additional power supply for the lock to work is required.

B. Outdoor unit installation

B1. Oblique Base Installation

1. Fasten the oblique base on the wall with screws. (1.4-1.6m high from the ground, Screw size: 4*30BA)
2. Connect the wires according to the wiring diagram.
3. Fix into the oblique base and fasten the bottom with screws. Finally seal the screw hole with the enclosed silicone cap.

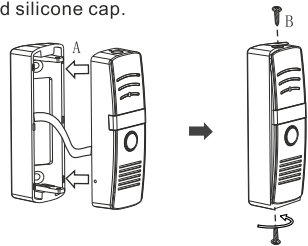
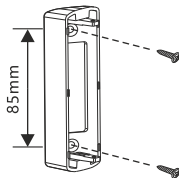

B2. Rain Shade Installation

1. Fasten the rain shade on the wall with screws. (1.4-1.6m high from the ground, Screw size: 4*30BA)
2. Connect the wires according to the wiring diagram.
3. Fix into the rain shade and fasten the bottom with screws. Finally seal the screw hole with the enclosed silicone cap.

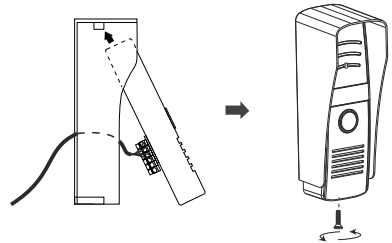
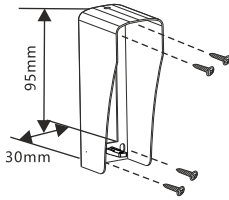

C. Installing the indoor unit

1. Fix the bracket on the wall with screws. (1.4-1.6m high from the ground)

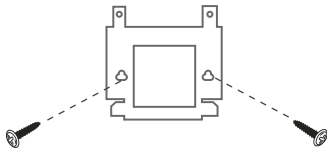

2. Connect the wires according to the wiring diagram.
3. Hang on the bracket.
4. Connection to power source.

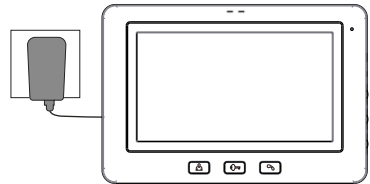

4. FUNCTION KEYS AND OPERATION INSTRUCTION

Indoor unit

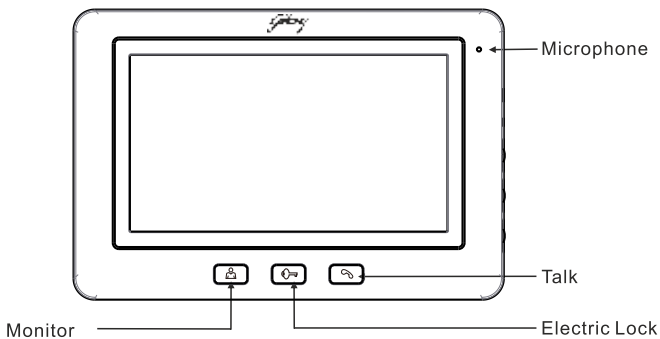

a. When the visitor presses **CALL button** on the outdoor unit, the indoor unit will ring and display the visitor's image on the screen. Press **TALK** "📞" button on the indoor unit to talk with the visitor. The talking time is 120s. During the 120s, you can:

- Press **ELECTRIC LOCK** "🔑" button to release the electric lock, or
- Press **TALK** "📞" button to hang up.

b. Press **MONITOR** "👤" button to monitor outside. The monitoring time is 40s. During the 40s, you can:

- Press **TALK** "📞" button to talk, during the talk, you can also unlock, or
- Press again **MONITOR** "👤" button to exit.

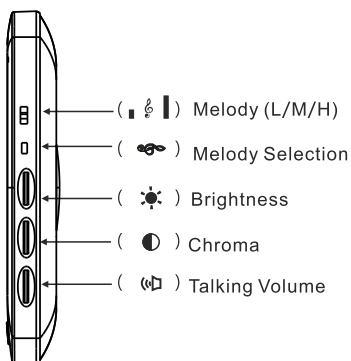

c. The **MELODY VOLUME** (🎵), **BRIGHTNESS** (☀️), **CHROMA** (●) and **TALKING VOLUME** (🔊) can be adjusted by the switches on the side of the device.

d. Press **MELODY SELECTION** (↔️) button to cycle through the different tones available for the doorbell in the monitor mode. There are 16 ringtones for option.

Outdoor Unit

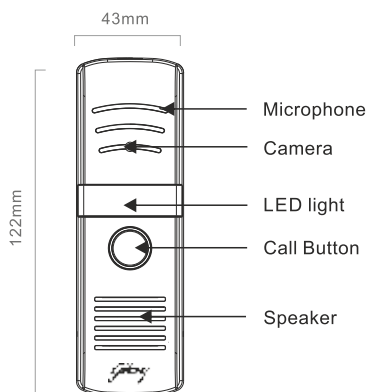

Specifications

Screen Resolution	800*480
Power Consumption	Static State <2W, Working State <7W
Volume	≥75dB (0.3m)
Operating Temperature	-10 °C ~ 50 °C
Operating Humidity	10%~90%(RH)
Camera Resolution	700 TVL
*Adapter	Input: AC100-240V Output: DC12V 1~2A

NOTE:

*Actual specification may vary, please refer to the label on the power adapter supplied.

5. INFORMATION ON E-WASTE HANDLING AND MANAGEMENT

Dear Customer,

The Ministry of Environment and Forests have published The E-waste (Management and Handling) Rules 2010 which comes in effect from 1st May 2012.

E-waste is defined as any electrical or electronic component of products in whole or in part, or rejects from their manufacturing or repair process which are intended to be discarded.

These rules apply to every producer; consumer or bulk consumer involved in the manufacture, sale, and purchase and processing of electrical and electronic equipment or components as specified in Schedule 1 (please refer to our website www.godrej.com under the 'Green Think' sec of Godrej Security Solutions Division Page for more details).

Under these rules, specific roles and responsibilities are defined for producers, consumers and recycles handling and managing e-waste.

E-waste is to be managed in an environmentally sound manner which means, taking steps to ensure that health and environment are protected from adverse effects of hazardous substance contained in such wastes.

Rule 6 of the E-waste (Management and Handling) Rules 2010 states that bulk consumers of electrical and electronic equipment shall be responsible for recycling of the e-waste generated by them. Bulk consumer means bulk users of electronic and electrical equipment such as Central Government or State Government Departments, public sector undertakings, banks, educational institutions, multinational organisations, and international agencies, private companies that are registered under the Factories Act, 1948 and Companies Act, 1956. The bulk consumers have to ensure that the e-waste generated by them is channelised to authorised collection centres or is taken back by the producers. They shall maintain records of e-waste generated by them in Form 2 and make such records available for scrutiny by the State Pollution Control or the Pollution Control Committee concerned.

All consumers of electrical and electronic equipment irrespective of their status as bulk consumers or not, shall ensure that e-waste generated by them is channelized to authorized collection centres (s) or registered dismantler(s), or recycler(s) or is returned to the pick-up/take back services provided by the producers. (Please refer to our website www.godrej.com under the 'Green Think' sec of Godrej Security Solutions Division Page for more details).

All our products intended to be recycled under the category of e-waste (as defined above) carry a label or stamp of the WEEE symbol (A wheelie bin with a cross), which states that it falls under the hazardous waste category and is not to be disposed of along with normal garbage.

We seek your support in ensuring environmentally sound management of e-waste and aid us in sustaining our earth's natural resources and maintaining the earth's green cover intact for the benefit of our future generations.



RECORD OF PURCHASE

Please fill your details below for future reference.

Date of purchase: _____

Product model: _____

Name & address of Distributor/Dealer: _____

Distributor phone number: _____

FOR SAFETY, PLEASE READ THIS MANUAL PRIOR TO USE.



Godrej & Boyce Mfg. Co. Ltd., Godrej Security Solutions
Regd. Office: Plant No. 17, Pirojshanagar,
Vikhroli, Mumbai - 400079

 **Toll Free:** 1800 209 9955 (**Sales & Service**)

 **Whatsapp Support:** +91 9321665511 (**Service**)

 **Visit:** www.godrejsecure.com

 **Email:** secure@godrej.com (**Sales**), secare@godrej.com (**Service**)

Follow us:  www.facebook.com/GodrejSecure

 www.twitter.com/godrejsecure

An ISO 9001:2015, ISO 14001:2015, ISO 45001:2018

Products Marketed and Serviced by Godrej and Boyce Mfg. Co. Ltd.